

SKORPION Trapped Key Interlocking with Key Exchange

THE SKORPION RANGE - AVAILABLE IN STAINLESS STEEL 316 OR DIE CAST:

ISOLATION



ISB1

KEY EXCHANGE



SS-KE-NS5 shown above
Available with up to 10 Keys

INTERLOCKING



SS-TS

PRODUCT OVERVIEW:

The SKORPION Trapped Key System has been developed to provide extremely robust mechanical coded key safeguarding and interlocking for hazardous machinery.

The system works on the principle of releasing factory coded mechanical keys in a pre-determined sequence to ensure machine power is isolated before any access can be gained to hazardous or dangerous machinery.

After the machine control has been isolated (first key turned in the system) the key from the isolator can then be used to release other trapped keys to enable access to the guarded areas.

After release of the first key (power isolation) safeguarding can be achieved without the need for electrical wiring, this makes the system ideal for use in harsh environments.

When used in conjunction with interlock sensing they can be used to achieve up to PLe/Cat4 to ISO13849-1.



SS-HS

APPLICATION:

A trapped-key guarding system relies upon the transfer of keys between a power isolation switch (or control switch) and a locking mechanism fixed on a guard.

The essential feature of the system is that a removable key is trapped either in the guard lock, or in the power isolation switch. The lock on the guard is arranged so that the key can be released only when the guard has been closed and locked. This allows transfer of the key from the guard to the power isolation switch.

Closing the switch traps the key, so that it cannot be removed while the switch is in the ON position.

If there is more than one source of power, and therefore more than one circuit breaking element to be actuated, then a key-exchange box is necessary, to which all keys have to be transferred and locked in before the access key, which is of a different coding, can be released for transfer to the guard lock.

Where there is more than one guard, the exchange box will accommodate an equivalent number of access keys.

Where a number of operations have to be carried out in a pre-determined definite sequence, then the transferable key is locked in and exchanged for a different one at each stage.



SS-BS

ADVANTAGES:

- No reduction of integrity due to the distance between movable guard and control system.
- High mechanical integrity, robust fixings and holdings suitable for all types of guards.
- Eliminates the need for electrical wiring to each movable guard.
- Fully Stainless Steel 316 version is suitable when the movable guard is placed in harsh or hostile environments.
- Suitable for CIP and SIP cleaning processes and can be high pressure hosed with detergents at high temperatures.
- Can be used where the movable guard requires to be removed completely.
- All keys are coded in the factory and it is virtually impossible to override the system.
- A trapped key system provides a quick yet safe and reliable access to machinery.
- Use of a trapped key system can also prevent shortcuts and enforce a logical set of procedures that need to be satisfied.
- Until the isolator key is returned to its original position within the lock, there is no way to enable the machinery to be re-started.

SKORPION Trapped Key Interlocking with Key Exchange

KEY EXCHANGE DIE CAST METAL ORDERING:

M-KE-NS4

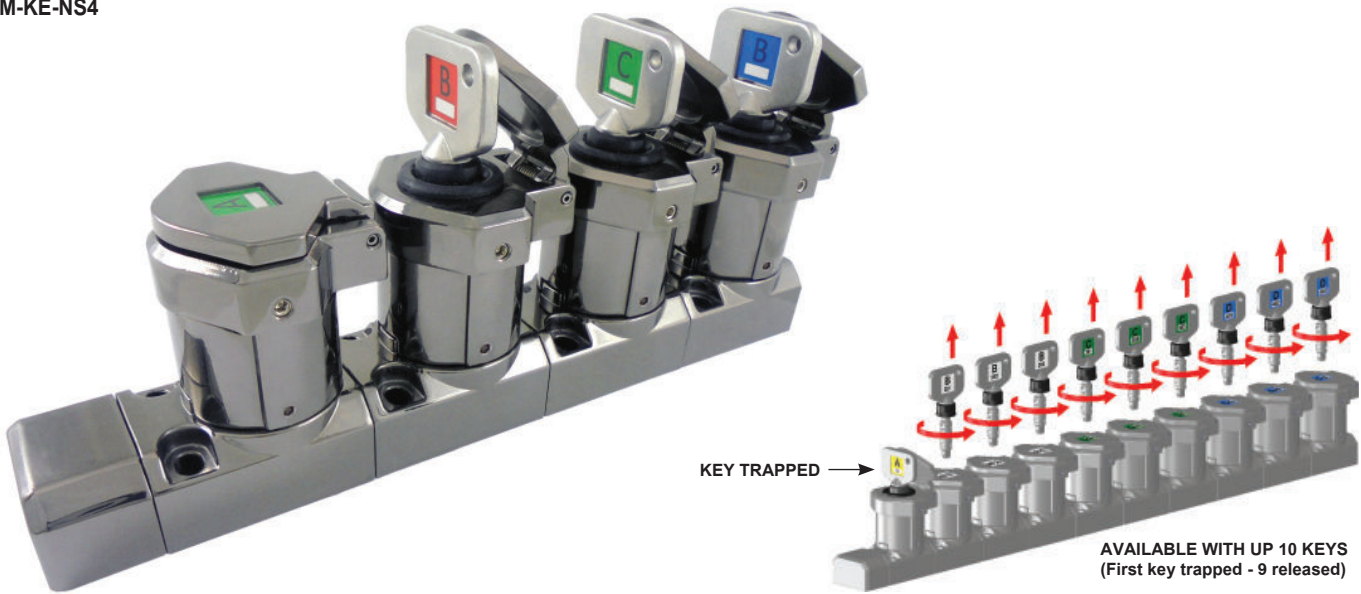

KEY TRAPPED →

AVAILABLE WITH UP TO 10 KEYS
(First key trapped - 9 released)

Sales Number	KEY EXCHANGE - DIE CAST METAL (Mirror Finish)
M-KE-NS2	2 Key
M-KE-NS3	3 Key
M-KE-NS4	4 Key
M-KE-NS5	5 Key
M-KE-S6	6 Key
M-KE-S7	7 Key
M-KE-S8	8 Key
M-KE-S9	9 Key
M-KE-S10	10 Key

First key TRAPPED
All remaining keys can be released non-sequentially.

First key TRAPPED
All remaining keys are then released sequentially.

BOLT INTERLOCKS (not suitable for guard access) DIE CAST METAL ORDERING:

M-BS



Sales Number	BOLT INTERLOCK SINGLE KEY DIE CAST METAL (Mirror Finish)
M-BS	Key trapped - bolt retracted

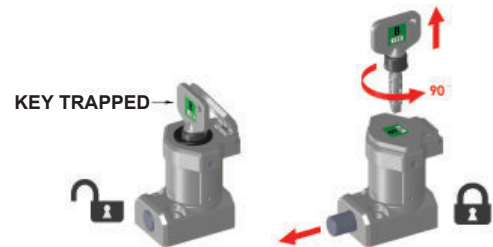

M-BD-11

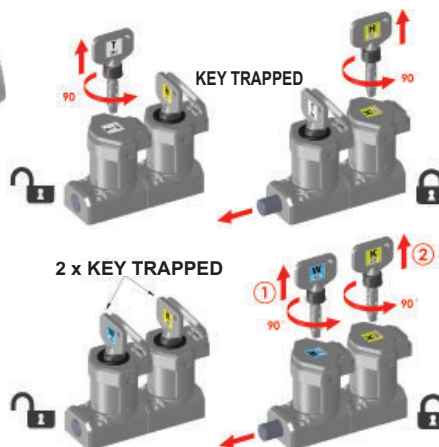

Sales Number	BOLT INTERLOCK DUAL KEY DIE CAST METAL (Mirror Finish)
M-BD-11	2 keys - 1 key trapped 1 key free - bolt retracted

Sales Number	BOLT INTERLOCK DUAL KEY DIE CAST METAL (Mirror Finish)
M-BD-20	2 keys trapped - bolt retracted

SKORPION Trapped Key Interlocking with Key Exchange

HANDLE INTERLOCKS DIE CAST METAL ORDERING:

M-HS



Sales Number	HANDLE INTERLOCK SINGLE KEY DIE CAST METAL (Mirror Finish)
M-HS	Key trapped - actuator unlocked (spring action handle)
M-HS-C	Key trapped - actuator unlocked (chain fixed to handle)

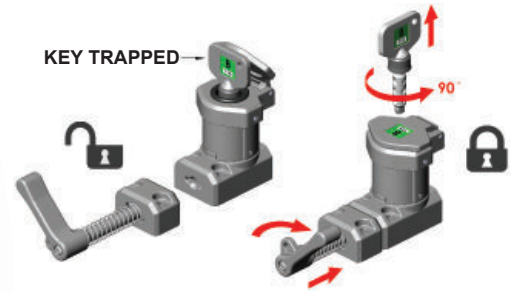

M-HS-C



M-HD-11



Sales Number	HANDLE INTERLOCK DUAL KEY DIE CAST METAL (Mirror Finish)
M-HD-11	2 sequential keys - one key trapped one key free - actuator unlocked (spring action handle)
M-HD-C-11	2 sequential keys - one key trapped one key free - actuator unlocked (chain fixed to handle)

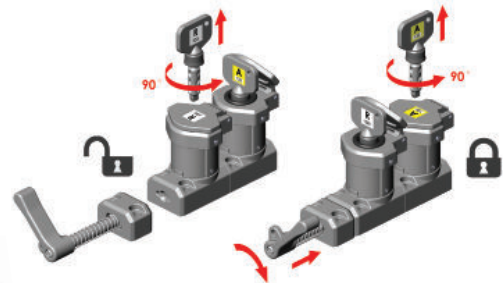

M-HD-C-11



SKORPION Trapped Key Interlocking with Key Exchange

TONGUE INTERLOCKS (Single Key) DIE CAST METAL ORDERING:

M-TS



*See below for Actuator options.

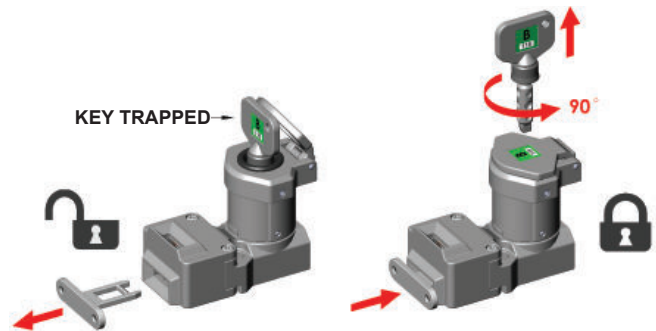

Sales Number	TONGUE INTERLOCK SINGLE KEY DIE CAST METAL (Mirror Finish) Holding Force (ISO14119) F1 Max 3000N Fzh 2307N
M-TS	Key trapped - actuator unlocked

TONGUE INTERLOCKS (Dual Key) DIE CAST METAL ORDERING:

M-TD-11



*See below for Actuator options.

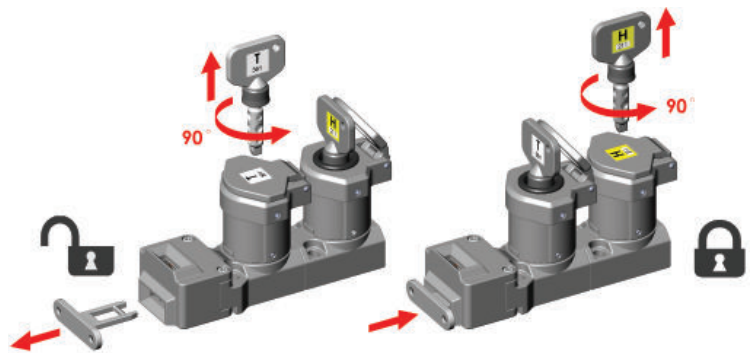

Sales Number	TONGUE INTERLOCK DUAL KEY DIE CAST METAL (Mirror Finish) Holding Force (ISO14119) F1 Max 3000N Fzh 2307N
M-TD-11	2 sequential keys - one key trapped one key free - actuator unlocked

ACTUATORS FOR TONGUE INTERLOCK SWITCHES SELECTION CHART:



SALES NUMBER	ACTUATOR TYPE
140107	A = Standard Actuator Stainless Steel 316
140108	F = Flat Actuator Stainless Steel 316 with Plastic Cover
140110	HF = Heavy Duty Flexible Actuator Stainless Steel 316 and Die Cast
140111	HFH = Heavy Duty Flexible Actuator fully Stainless Steel 316

SKORPION Trapped Key Interlocking with Key Exchange

INTERLOCKING WITH CONTROL ISOLATION DIE CAST METAL ORDERING:

M-TS-CB



*See below for Actuator options.

Holding Force (ISO14119) F1 Max 3000N Fzh 2307N

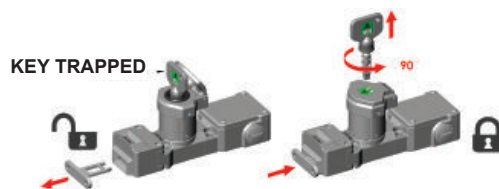

Sales Number	TONGUE INTERLOCK SINGLE KEY WITH CONTACT BLOCK DIE CAST METAL (Mirror Finish) Key Trapped - Actuator Unlocked - NC safety Contacts Open
M-TS-CB-22-N	Single Tongue Interlock with 2NC 2NO Contact Block - 1/2" NPT
M-TS-CB-31-N	Single Tongue Interlock with 3NC 1NO Contact Block - 1/2" NPT
M-TS-CB-22-M	Single Tongue Interlock with 2NC 2NO Contact Block - M20
M-TS-CB-31-M	Single Tongue Interlock with 3NC 1NO Contact Block - M20

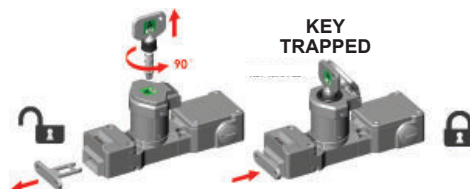

Sales Number	TONGUE INTERLOCK SINGLE KEY WITH CONTACT BLOCK DIE CAST METAL (Mirror Finish) Key Free - Actuator Unlocked - NC Safety Contacts Open
M-TSR-CB-22-N	Single Tongue Interlock with 2NC 2NO Contact Block - 1/2" NPT
M-TSR-CB-31-N	Single Tongue Interlock with 3NC 1NO Contact Block - 1/2" NPT
M-TSR-CB-22-M	Single Tongue Interlock with 2NC 2NO Contact Block - M20
M-TSR-CB-31-M	Single Tongue Interlock with 3NC 1NO Contact Block - M20

EXPLOSION PROOF INTERLOCKING WITH CONTROL ISOLATION DIE CAST METAL ORDERING:

M-TS-CB EX



*See below for Actuator options.



Trapped Key with ATEX EExd IIC T6 certified explosion proof contact blocks. The explosion proof contact blocks conform to European harmonized standard EN60079-0 and EN60079-1 and can be used in European Zone 1, 2, 21, 22 environments. (Gas and Dust). Designed for use in oil, petro-chemical, pharmaceutical, food processing and packaging applications where the potential for explosive atmospheres are present.

Exd IIC T6 (-20 ≤ Ta ≤ +60C)

Ex tb IIIC T85C (-20 ≤ Ta ≤ +60C) Db

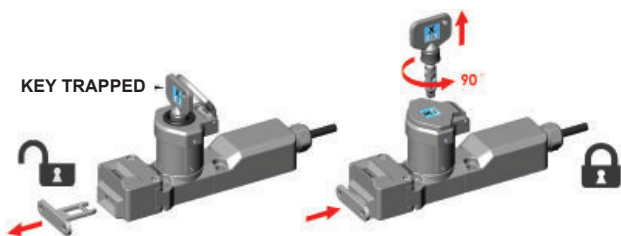

Sales Number	TONGUE INTERLOCK SINGLE KEY WITH EXPLOSION PROOF CONTACT BLOCK DIE CAST (Mirror Finish) Holding Force (ISO14119) F1 Max 3000N Fzh 2307N
M-TS-CB-22-EX	Single Tongue Interlock with 2NC 2NO Pre-wired EX Block
M-TS-CB-11-EX	Single Tongue Interlock with 1NC 1NO Pre-wired EX Block



SALES NUMBER	ACTUATOR TYPE
140107	A = Standard Actuator Stainless Steel 316
140108	F = Flat Actuator Stainless Steel 316 with Plastic Cover
140110	HF = Heavy Duty Flexible Actuator Stainless Steel 316 and Die Cast
140111	HFH = Heavy Duty Flexible Actuator fully Stainless Steel 316