



Trapped Key Tongue Interlock with control switch – Types TS-CB TS-CB-EX

Operating Instructions



Sales Number	TONGUE INTERLOCK SINGLE KEY WITH CONTACT BLOCK STAINLESS STEEL 316 Holding Force (ISO14119) F1 Max 3000N Fzh 2307N
SS-TS-CB-22-N	Single Tongue Interlock with 2NC 2NO Contact Block - 1/2" NPT
SS-TS-CB-31-N	Single Tongue Interlock with 3NC 1NO Contact Block - 1/2" NPT
SS-TS-CB-22-M	Single Tongue Interlock with 2NC 2NO Contact Block - M20
SS-TS-CB-31-M	Single Tongue Interlock with 3NC 1NO Contact Block - M20

Sales Number	TONGUE INTERLOCK SINGLE KEY WITH CONTACT BLOCK DIE CAST METAL (Mirror Finish) Holding Force (ISO14119) F1 Max 3000N Fzh 2307N
M-TS-CB-22-N	Single Tongue Interlock with 2NC 2NO Contact Block - 1/2" NPT
M-TS-CB-31-N	Single Tongue Interlock with 3NC 1NO Contact Block - 1/2" NPT
M-TS-CB-22-M	Single Tongue Interlock with 2NC 2NO Contact Block - M20
M-TS-CB-31-M	Single Tongue Interlock with 3NC 1NO Contact Block - M20

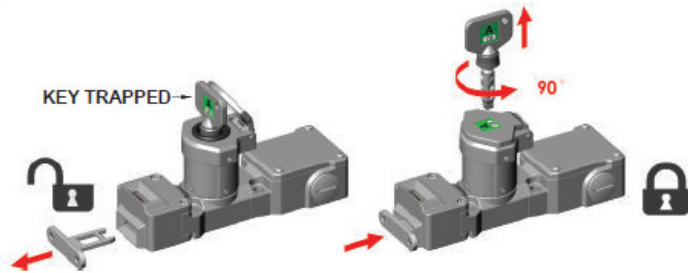

Sales Number	TONGUE INTERLOCK SINGLE KEY WITH EXPLOSION PROOF CONTACT BLOCK STAINLESS STEEL 316 Holding Force (ISO14119) F1 Max 3000N Fzh 2307N
SS-TS-CB-22-EX	Single Tongue Interlock with 2NC 2NO Pre-wired EX Block
SS-TS-CB-11-EX	Single Tongue Interlock with 1NC 1NO Pre-wired EX Block

Sales Number	TONGUE INTERLOCK SINGLE KEY WITH EXPLOSION PROOF CONTACT BLOCK DIE CAST (Mirror Finish) Holding Force (ISO14119) F1 Max 3000N Fzh 2307N
M-TS-CB-22-EX	Single Tongue Interlock with 2NC 2NO Pre-wired EX Block
M-TS-CB-11-EX	Single Tongue Interlock with 1NC 1NO Pre-wired EX Block

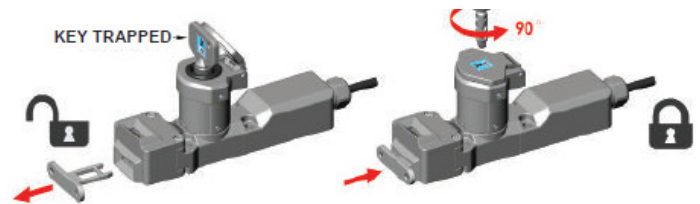

READ AND UNDERSTAND THESE INSTRUCTIONS BEFORE INSTALLING, OPERATING, OR MAINTAINING THIS EQUIPMENT.

The product is designed to be a component of a customized safety oriented control system. It is the responsibility of the user to ensure the correct overall functionality of its systems and machines. IDEM, its subsidiaries and affiliates, are not in a position to guarantee all of the characteristics of a given system or product not designed by IDEM.

INSTALLATION: Installation must only be carried out by competent personnel and in accordance with these instructions.

Always use correct size metal mounting bolts (M6). Tightening torque 2Nm. Ensure that the holding force is sufficient to withstand the static forces applied during normal use and dynamic effects caused by bouncing of the guard shall not create an impact reaction force which exceeds the holding force. If the expected impact reaction forces are higher than the specified holding force for the switch, then design measures must be applied to avoid the force.

WARNING: ALWAYS OBSERVE ELECTRICAL RATINGS FOR EX VERSIONS.

MAINTENANCE: Every month: Check all circuits for correct function. If the key or housing display signs of mechanical damage then remove and replace. IDEM will not accept responsibility for failure of the switch functions if the installation and maintenance requirements are not implemented.

THESE INSTRUCTIONS FORM PART OF THE PRODUCT WARRANTY.

Trapped Key Tongue Interlock with control switch – Types TS-CB TS-CB-EX

PRODUCT DIMENSIONS

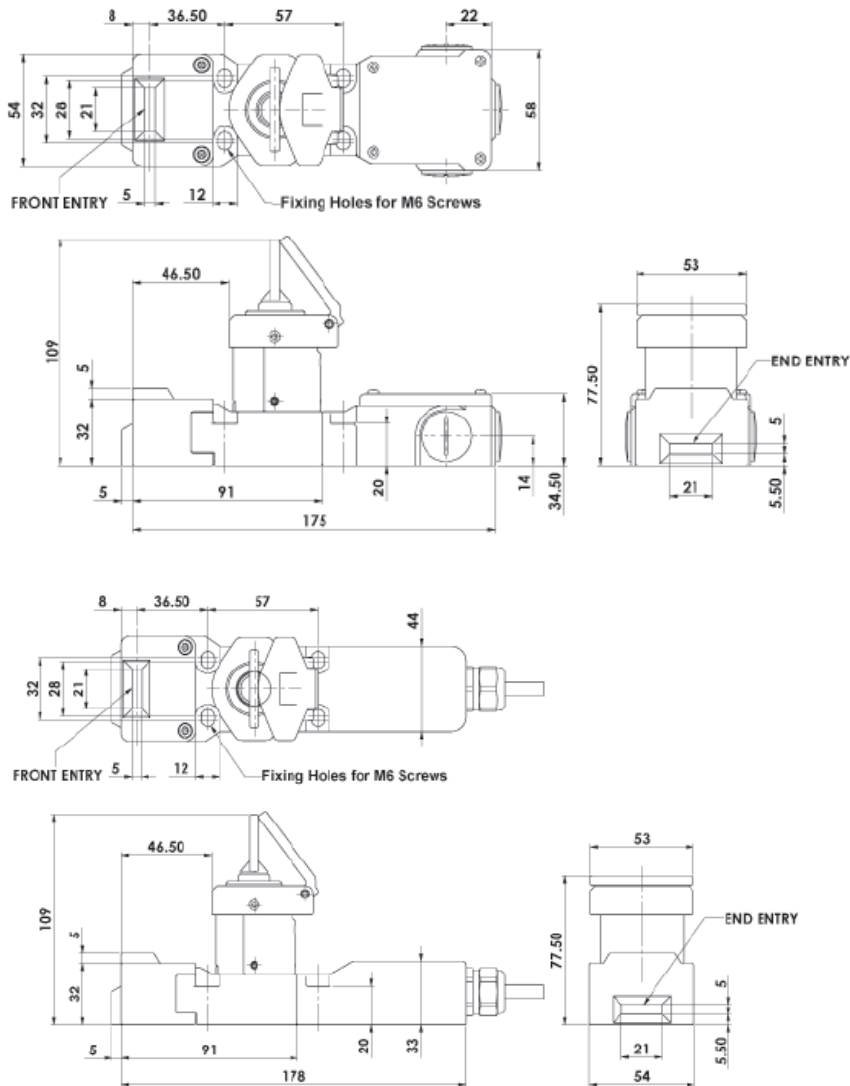

Standard Contact blocks

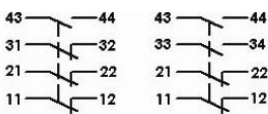

TECHNICAL SPECIFICATIONS

Body Material: Stainless steel or die cast
Operating Temperature: -20C. to +60C.
Holding Force: 3000N. (F1max.) 2307N. (Fzh)
Mechanical Life (B10d): 1,000,000 cycles

EX versions:

EX Internal switch:

Type: IDEM LS-EX
Classification: Ex d IIC T6 (-20C Ta 60C) Gb
 Ex tb IIIC T85C (-20C Ta 60C) Db
Rated Voltage: 250V ac/dc
Rated Current: 2 pole 4A. 4 pole 2.5A.

1 NC 1 NO

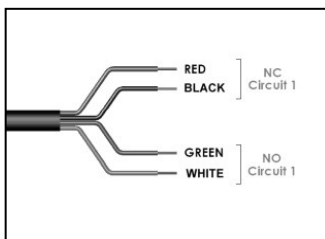

2 NC 2 NO

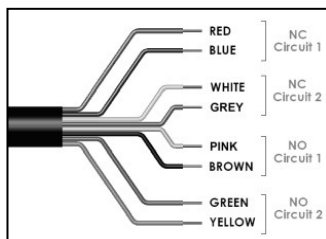

2NC

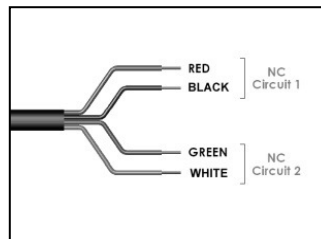

IMPORTANT-

SPECIFIC CONDITIONS OF USE FOR EX VERSIONS:

THE INTEGRAL CABLE SHALL BE SUITABLY PROTECTED FROM PHYSICAL DAMAGE AND ABRASION. THE INTEGRAL CABLE IS TO BE TERMINATED IN A SUITABLE TERMINAL FACILITY.