

SCR - Viper Safety Relays

SCR-73-i

The new generation of safety relays from IDEM

Single or Dual channel operation

Monitored Manual or Auto Start/Reset

7 Safety output contacts
3 Auxiliary output contacts

Contactor feedback check

Easy diagnosis of status via 6 LEDs

24Vac/dc operation

Up to PLe, SILCL 3, Category 4

45mm DIN rail mounting

Emergency stop and guard interlock monitoring

Output expansion units available to increase number of outputs.

The Viper Safety Relays range from IDEM are designed to meet the latest safety standards and offer enhanced LED diagnostics and simplified wiring. Applications include safety interlock switches, emergency e-stop devices, door guard monitoring.

The Viper Safety Relays range includes output expansion units that can be directly wired to SCR-73-i safety relay to increase the number of safety output contacts. The expansion modules are available with either immediate or time-delayed output contacts.

The SCR-73-i internal logic uses force guided relays to achieve cross monitoring, this ensures that a single fault does not lead to the loss of the safety function and that all faults are detected at or before the next safety demand.

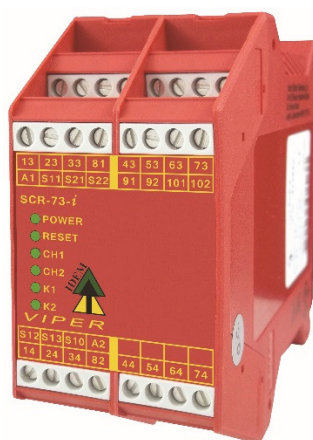

Functional Description

When the control line inputs are closed and the start/reset condition has been met the safety output contacts close.

The safety relay outputs open when the inputs are de-activated or if there is a power failure. When dual channel inputs are used it is not necessary to synchronise switching of the input channels.

When operating in the monitored manual reset configuration the reset button must perform a make-then-break action before the safety relay will activate.

External device feedback contacts can be monitored via the reset loop.

Block Diagram and Connections

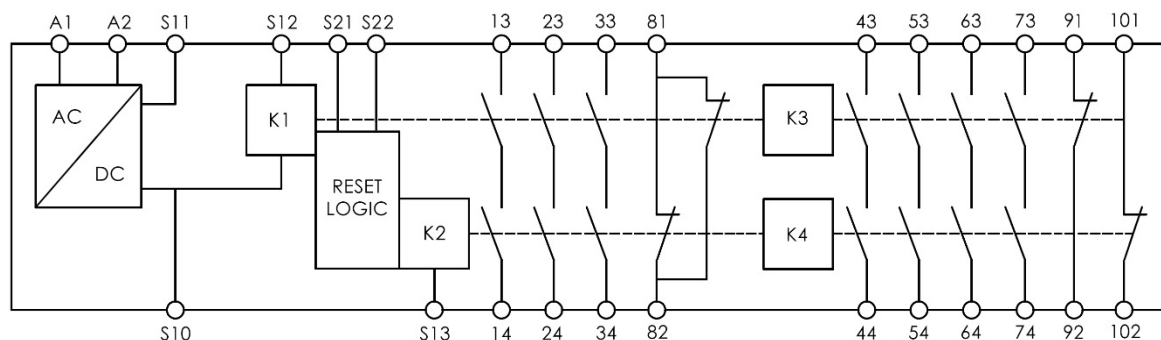

A1	Power Supply	S21	Auto Reset	53-54	Safety Output Contact 5
A2	Power Supply	S22	Manual Reset	63-64	Safety Output Contact 6
S11	24Vd.c. Control Voltage	13-14	Safety Output Contact 1	73-74	Safety Output Contact 7
S12	Control Line	23-24	Safety Output Contact 2	81-82	Auxiliary Output Contact 1
S13	Control Line	33-34	Safety Output Contact 3	91-92	Auxiliary Output Contact 2
S10	Control Line	43-44	Safety Output Contact 4	101-102	Auxiliary Output Contact 3

Variants

Part No.	Description
280005	SCR-73-i, AC/DC 24 V, (50-60Hz), Fixed screw terminals
280005-P	SCR-73-i, AC/DC 24 V, (50-60Hz), Pluggable Terminals

Application Circuits

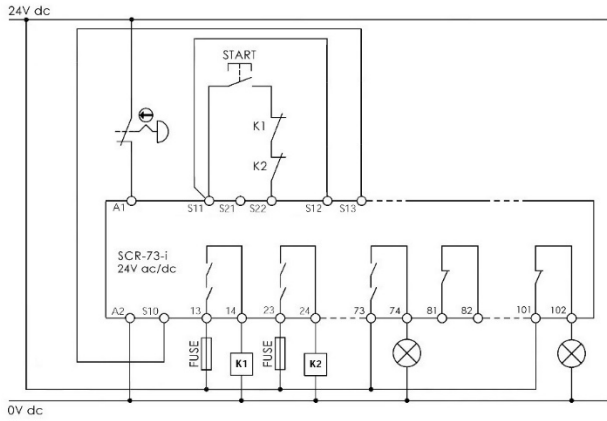

Fig.1 SCR-73-i, Single Channel, E-Stop, Manual Reset

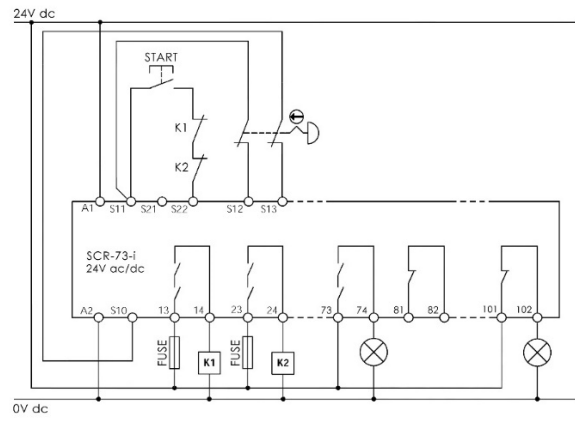

Fig.2 SCR-73-i, Dual Channel, E-Stop, Manual Reset

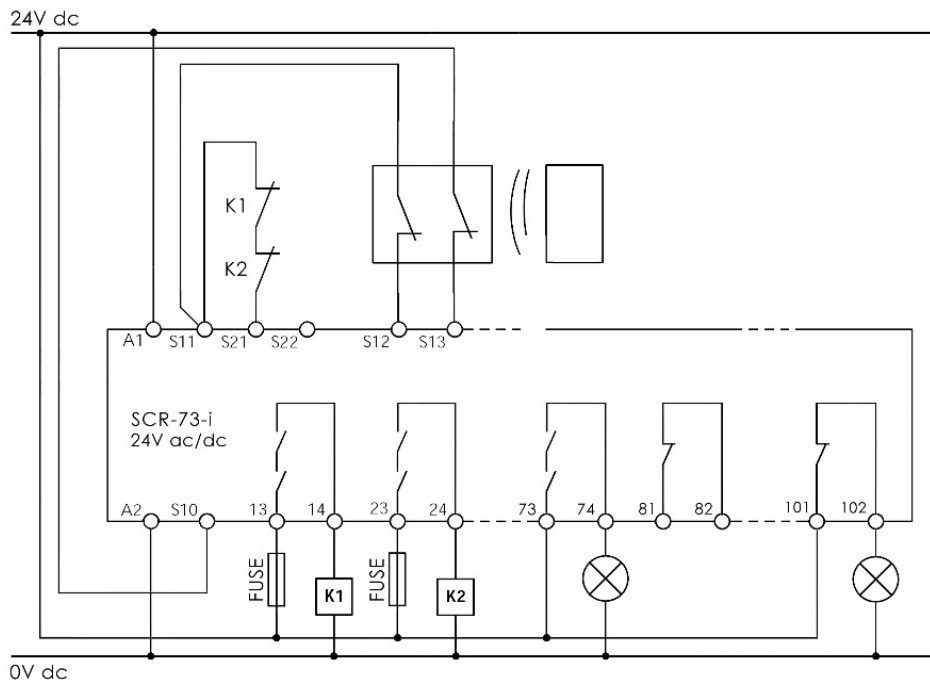

Fig.2 SCR-73-i, Dual Channel, Non-Contact Switch, Auto Reset

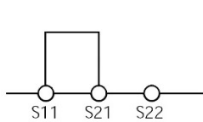

Fig.3 Auto Reset

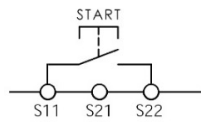

Fig.4 Manual Reset

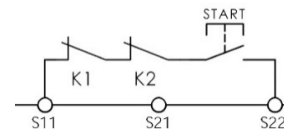

Fig.5 Contactor Feedback Check (Auto or Manual Reset)

Electrical Connection

- A power supply unit with electrical isolation from the mains supply must be connected.
- External fusing of each safety output contact is necessary, a 4A slow-blow or 6A quick action must be provided.
- The maximum cabling and connecting resistance of control lines must not exceed 300 ohms.

Viper Safety Relays
SCR-73-i

Dimensions

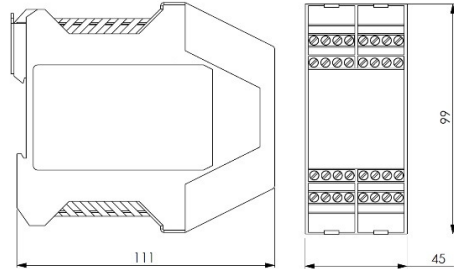

Diagnostic LEDs

13	23	33	81	43	53	63	73
A1	S11	S21	S22	91	92	101	102
SCR-73-i							
○ POWER							
○ RESET							
○ CH1							
○ CH2							
○ K1							
○ K2							
V I P E R							
S12	S13	S10	A2				
14	24	34	82	44	54	64	74

- POWER Power to the safety relay.
- RESET Reset loop S11-S21 or S11-S22 is closed.
- CH1 Channel 1 control loop S11-S12 is closed.
- CH2 Channel 2 control loop S13-S10 is closed.
- K1 Power to Internal relay K1.
- K2 Power to Internal relay K2.

Safety Characteristics

Characteristic Data according to IEC 62061

Safety Integrity Level	SIL3
PFH	8.4 E -10 (1/h) (0.8% of SIL3 (1 E -07 (1/h))
PFD _{av}	7.2 E -05 (1/h) (7.2% of SIL3 (1 E -03)

Characteristic Data according to EN ISO 13849-1

Performance Level	e
Category	4
MTTF _d	71 a (High)
Diagnostic Coverage	99% (High)

Specification

Standards EN/ISO13849-1; EN /SO13849-2; EN62061; EN60204-1; EN/ISO12100;UL508

Power supply Circuit

Operating voltage	24V AC/DC
Operating voltage tolerance	-15% - +10%
Rated supply frequency	50Hz – 60Hz
Rated supply current	130mA
Power consumption	24V 5W

Control Circuits

Rated output voltage	S11	24V DC
Input current	S11.S14	100mA
Response time		30ms
Release time		25ms
Recovery time		Approx. 1s

Output Circuits

Rated output voltage		250VAC
Max. current per output		6A
Max. total current all outputs		6A
Safety contact breaking capacity	AC	230V, 4A for AC-15
	DC	24V, 30W, 2A, DC-13
Minimum contact load		10V 10mA
Min. contact fuses		4A Slow blow, 6A Fast blow
Contact material		AgSnO ₂
Contact service life		10 x 10 ⁶

General Data

Rated impulse withstand voltage	4kV
Rated insulation voltage	250V
Degree of protection	IP20
Temperature range	-20C + 55C
Degree of contamination	2
Overvoltage category	III
Weight	0.3kg
Mounting	Any position

SAFETY WARNINGS



- Installation should only be carried out by competent and authorised personnel and in accordance with the instructions in this manual.
 - Only make electrical connections when the device is isolated from the main supply.
 - If "Automatic Start" is selected be aware that safety output contacts will switch immediately after the power supply is connected.
 - Opening the device will void the warranty. Never attempt to repair any device.
 - Adhere to Safety Checks.
 - **DO NOT DEFEAT, TAMPER, OR BYPASS THE SAFETY FUNCTION. FAILURE TO DO SO CAN RESULT IN DEATH OR SERIOUS INJURY.**
- L'installation doit être effectuée par un personnel compétent et autorisé et en conformité avec les instructions de ce manuel.
 - faites uniquement des connexions électriques lorsque l'appareil est isolé de l'alimentation principale.
 - Si "Démarrage automatique" est sélectionné être conscient que les contacts de sortie de sécurité passeront immédiatement après l'alimentation est connectée.
 - Ouverture de l'appareil annule la garantie. Ne jamais tenter de réparer tout appareil.
 - Adhérer à des contrôles de sécurité.
 - **NE DÉFAITE PAS, SABOTAGE, OU DE CONTOURNER LA FONCTION DE SÉCURITÉ. MANQUEMENT À S'Y PEUT ENTRAÎNER LA MORT OU DES BLESSURES GRAVES**

Installation and Maintenance

Installation should as per EN 60204-1 in addition to any local regulations. The safety relay should be mounted inside a cabinet enclosure and on a 35mm DIN rail according to DIN EN 60715. No maintenance is required, there are no serviceable parts. (Refer to Safety Checks). The product is designed to be a component of a customised safety orientated control system. It is the responsibility of the user to ensure the correct overall functionality of its systems and machines. IDEM, its subsidiaries and affiliates, are not in a position to guarantee all of the characteristics of a given system or product not designed by IDEM.

Information Regarding UL 508

Pilot Duty R300, B300
Single contact must be used

250V AC/DC / 6,0A Resistive Single contact must be used	250V AC/DC 6,0A General Purpose All contact at once can be used
---	---

USE COPPER OR COPPER-CLAD ALUMINUM CONDUCTORS

Maximum surround air temperature 40°C

Safety Checks:

1. Ensure the appropriate safety level is achieved for the application function.
2. The safety functions must be tested regularly. For applications where infrequent use is foreseeable, the system must have a manual function test. At least once per month for PLe Cat3/4 or once per year for PLd Cat3 (ISO13849-1 / ISO14119).

Declaration of Conformity

Manufacturer: IDEM SAFETY SWITCHES Ltd.
2 Ormside Close, Hindley Industrial Estate, Hindley Green, Wigan, WN2 4HR, UK

Product: Safety Emergency Stop Devices

Model types: SCR-73-i

The above products conform to the safety requirements of the following directives and standards:

Machinery Directive 2006/42/EC
EMC Directive 2014/30/EC
Low Voltage Directive 2006/95/EC

EN 13849-1:2015
EN 13849-2:2012
EN 62061:2005+A2:2015
EN 61508 (Parts 1-7): 2011-02
EN 60204-1:2018
EN 50178:1997

Third Party Certification: NB 0035 TUV Rheinland Industrie Service GmbH

M. Mohtasham Managing Director